

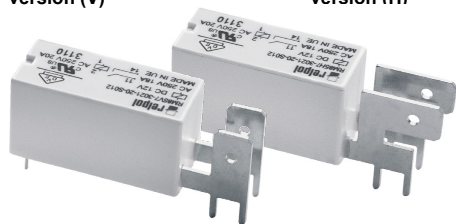



# RM85 faston miniature relays

version (V)

version (H)



- Relays designed for continuous operation\*
- **Coil terminals for PCB, contacts terminals for PCB and flat insert connectors - faston 250 (6,3 x 0,8 mm), faston arrangement: vertical version (V) and horizontal version (H)**
- Ambient temperature up to 105 °C • CTI 250 • Reinforced insulation
- DC coils - sensitive, insulation class F: 155 °C • Applications: for control of operation of heating elements and motors of household equipment and catering industry devices, for control of electromagnetic valves, in many other applications • Compliance with standards: EN 60730-1, EN 60335-1
- Recognitions, certifications, directives: RoHS,   

## Contact data

Number and type of contacts		1 NO	
Contact material		<b>AgSnO<sub>2</sub></b>	
Rated / max. switching voltage	AC	250 V / 400 V	
Min. switching voltage		10 V	
Rated load (capacity)	AC1	20 A / 250 V AC	
	AC15	3 A / 120 V	1,5 A / 240 V (B300)
	DC1	20 A / 24 V DC	
	DC13	0,22 A / 120 V	0,1 A / 250 V (R300)
Motor load	acc. to UL 508	1/2 HP	240 V AC, 4,9 FLA, single-phase motor 
	AC3 acc. to IEC 60947-4-1	0,5 kW	240 V AC, single-phase motor
Min. switching current		10 mA	
Max. make current		30 A	
Rated current		20 A	
Max. breaking capacity	AC1	5 000 VA	
Min. breaking capacity		1 W	
Contact resistance		≤ 100 mΩ	100 mA, 24 V
Max. operating frequency	• at rated load AC1 • no load	600 cycles/hour 72 000 cycles/hour	

## Coil data

Rated voltage	DC	5, 6, 9, 10, <b>12</b> , 18, <b>24</b> , 48 V
Must release voltage		DC: ≥ 0,1 U <sub>n</sub>
Operating range of supply voltage		see Table 1
Rated power consumption	DC	0,25 W

## Insulation according to EN 60664-1

Insulation rated voltage		400 V AC
Rated surge voltage		4 000 V 1,2 / 50 μs
Overvoltage category		III
Insulation pollution degree		3
Dielectric strength		
• between coil and contacts		5 000 V AC type of insulation: reinforced
• contact clearance		1 000 V AC type of clearance: micro-disconnection
Contact - coil distance	• clearance • creepage	≥ 10 mm ≥ 10 mm

## General data

Operating / release time (typical values)		8 ms / 3 ms
Electrical life (number of cycles)		
• resistive AC1		> 10 <sup>4</sup> 20 A, 230 V AC, 85 °C > 5 x 10 <sup>4</sup> 16 A, 230 V AC, 105 °C
• cosφ		see Fig. 1
Mechanical life (cycles)		> 3 x 10 <sup>7</sup>
Dimensions (L x W x H)		vertical version (V): 40,5 x 12,7 x 15,7 mm horizontal version (H): 44,5 x 12,7 x 15,7 mm
Weight		16 g
Ambient temperature	• storage (non-condensation and/or icing) • operating	-40...+105 °C -40...+105 °C
Cover protection category		IP 40 EN 60529
Environmental protection		RTII EN 61810-1
Shock resistance		30 g
Vibration resistance		10 g 10...150 Hz
Solder bath temperature		max. 270 °C
Soldering time		max. 5 s

The data in bold type relate to the standard versions of the relays. \*The relays are designed for continuous operation while maintaining the parameters declared in the data sheet.  For single phase motors for 110-120 V AC do not use motors with higher FLA than given for 240 V AC.

# RM85 faston miniature relays

## Dimensions

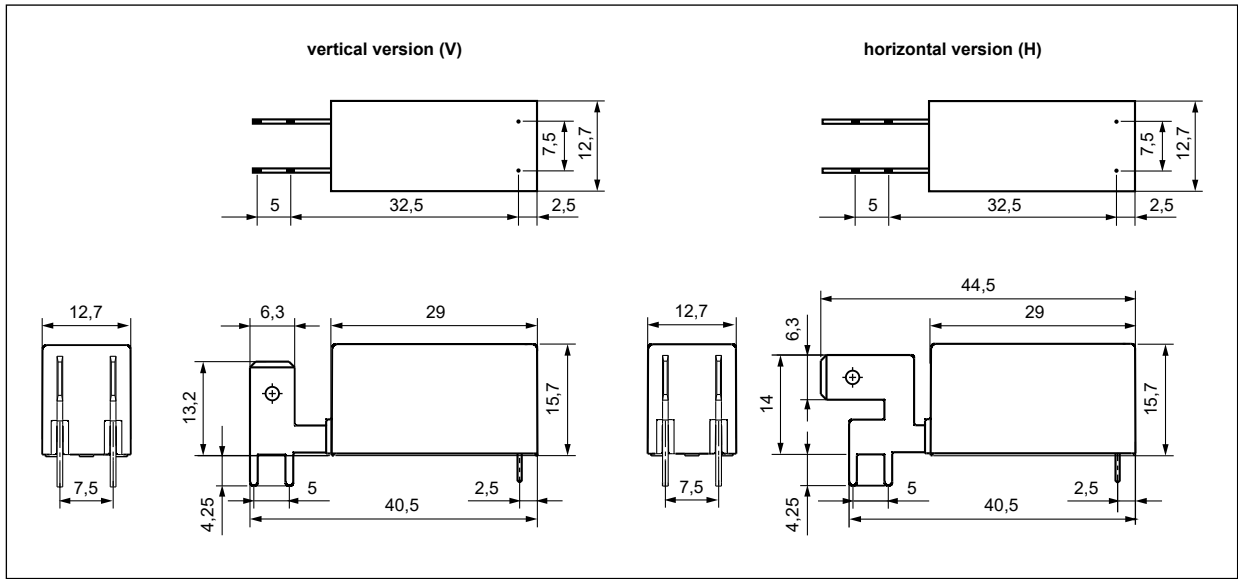

## Connection diagram (pin side view)

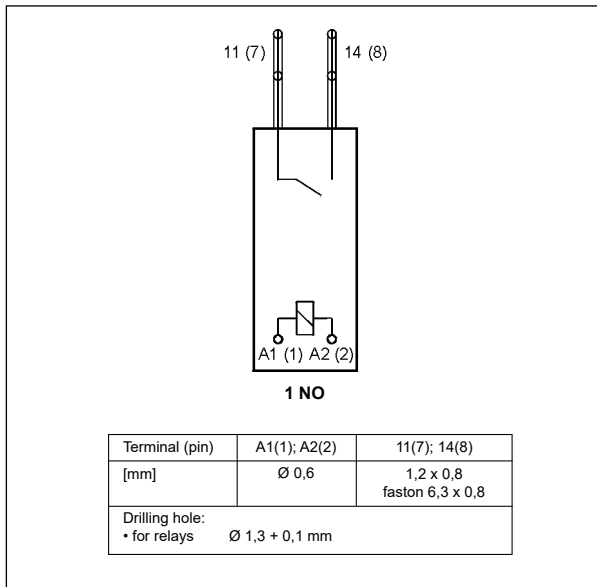

## Electrical life reduction factor at AC inductive load

Fig. 1

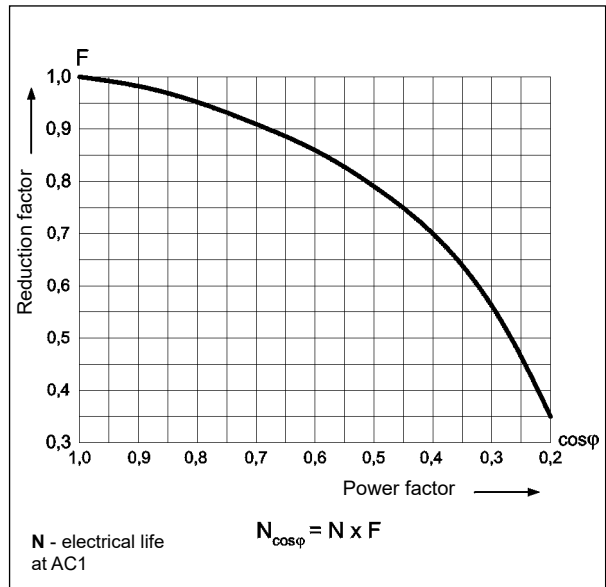

## Pinout (solder side view)

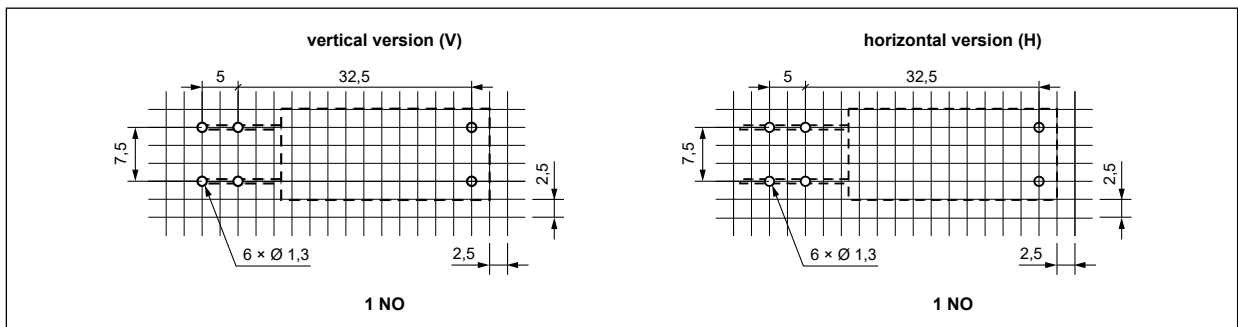

# RM85 faston

## miniature relays

### Mounting

Relays **RM85 faston** are designed for: • direct PCB mounting • connection of load with flat insert connectors - faston 250 (6,3 x 0,8 mm).

Coil data - DC voltage version, sensitive

Table 1

Coil code	Rated voltage V DC	Coil resistance at 20 °C Ω	Acceptable resistance	Coil operating range V DC	
				min. (at 20 °C)	max. (at 20 °C)
S005	5	102	± 10%	3,75	15,0
S006	6	144	± 10%	4,50	18,0
S009	9	330	± 10%	6,75	27,0
S010	10	380	± 10%	7,50	30,0
<b>S012</b>	<b>12</b>	<b>580</b>	<b>± 10%</b>	<b>9,00</b>	<b>36,0</b>
S018	18	1 300	± 10%	13,50	54,0
<b>S024</b>	<b>24</b>	<b>2 300</b>	<b>± 10%</b>	<b>18,00</b>	<b>72,0</b>
S048	48	9 340	± 10%	36,00	144,0

The data in bold type relate to the standard versions of the relays.

### Ordering codes

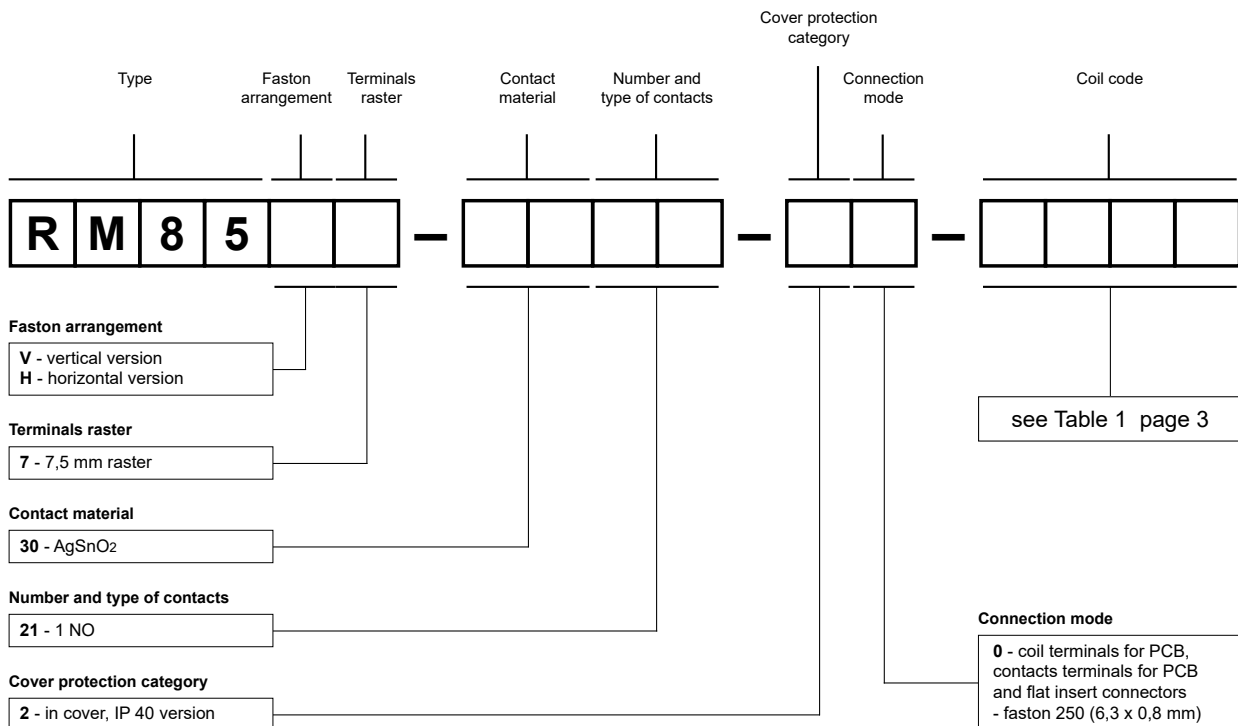

Example of ordering code:

**RM85V7-3021-20-S012**

relay **RM85 faston**, vertical version, coil terminals for PCB, contacts terminals for PCB and flat insert connectors - faston 250 (6,3 x 0,8 mm), 7,5 mm terminals raster, one normally open contact, contact material AgSnO<sub>2</sub>, sensitive coil voltage 12 V DC, in cover IP 40

### PRECAUTIONS:

1. Ensure that the parameters of the product described in its specification provide a safety margin for the appropriate operation of the device or system and never use the product in circumstances which exceed the parameters of the product. 2. Never touch any live parts of the device. 3. Ensure that the product has been connected correctly. An incorrect connection may cause malfunction, excessive heating or risk of fire. 4. In case of any risk of any serious material loss or death or injuries of humans or animals, the devices or systems shall be designed so to equip them with double safety system to guarantee their reliable operation.